

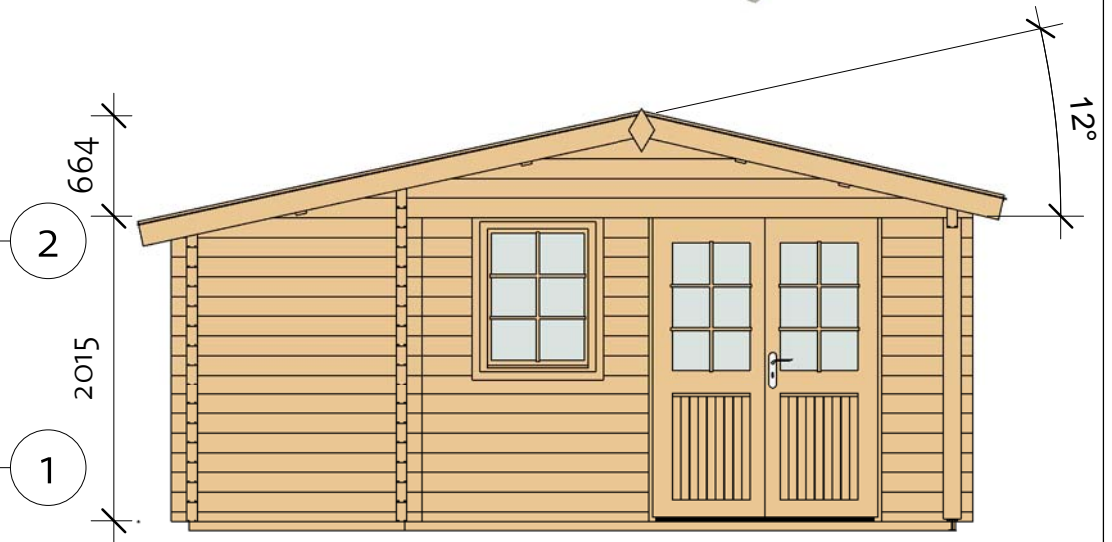

# Glendale 70 mm

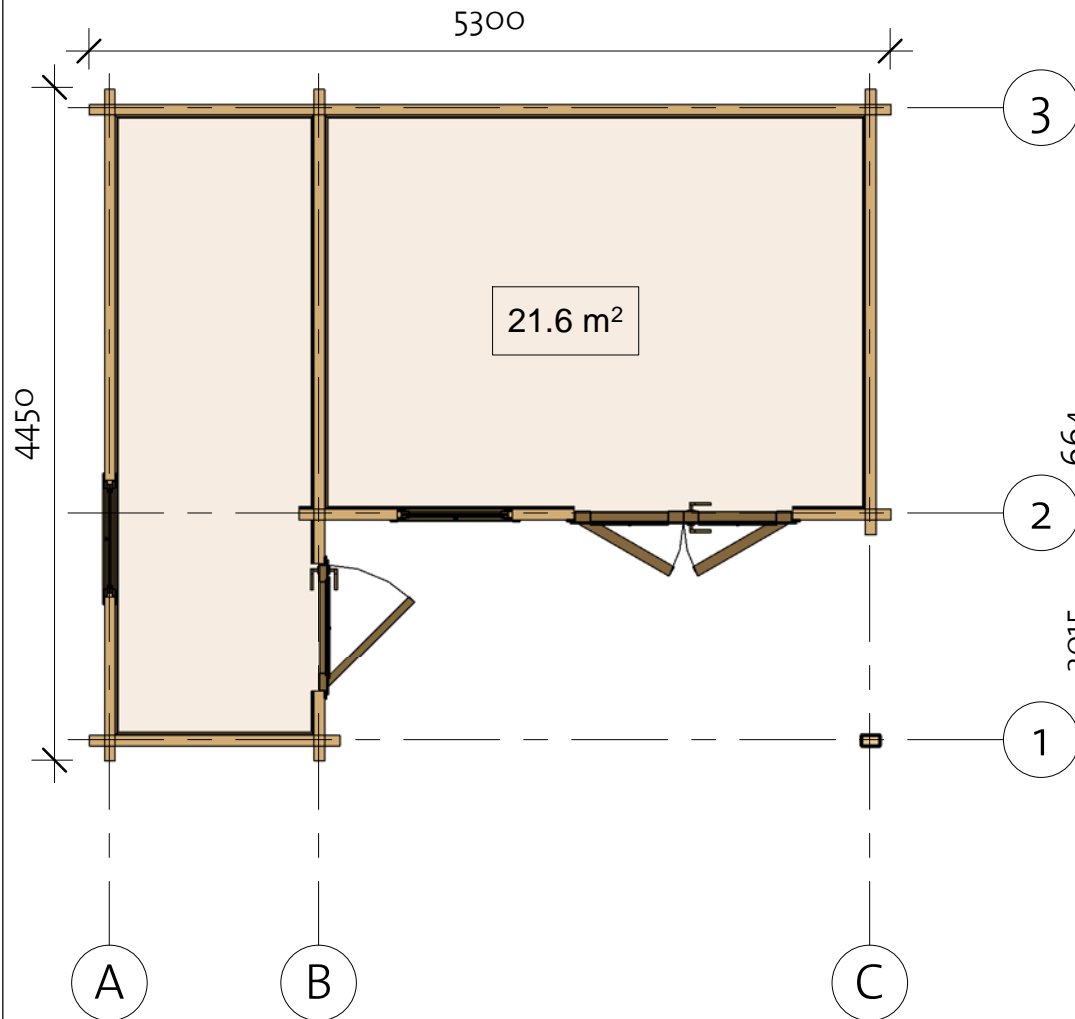
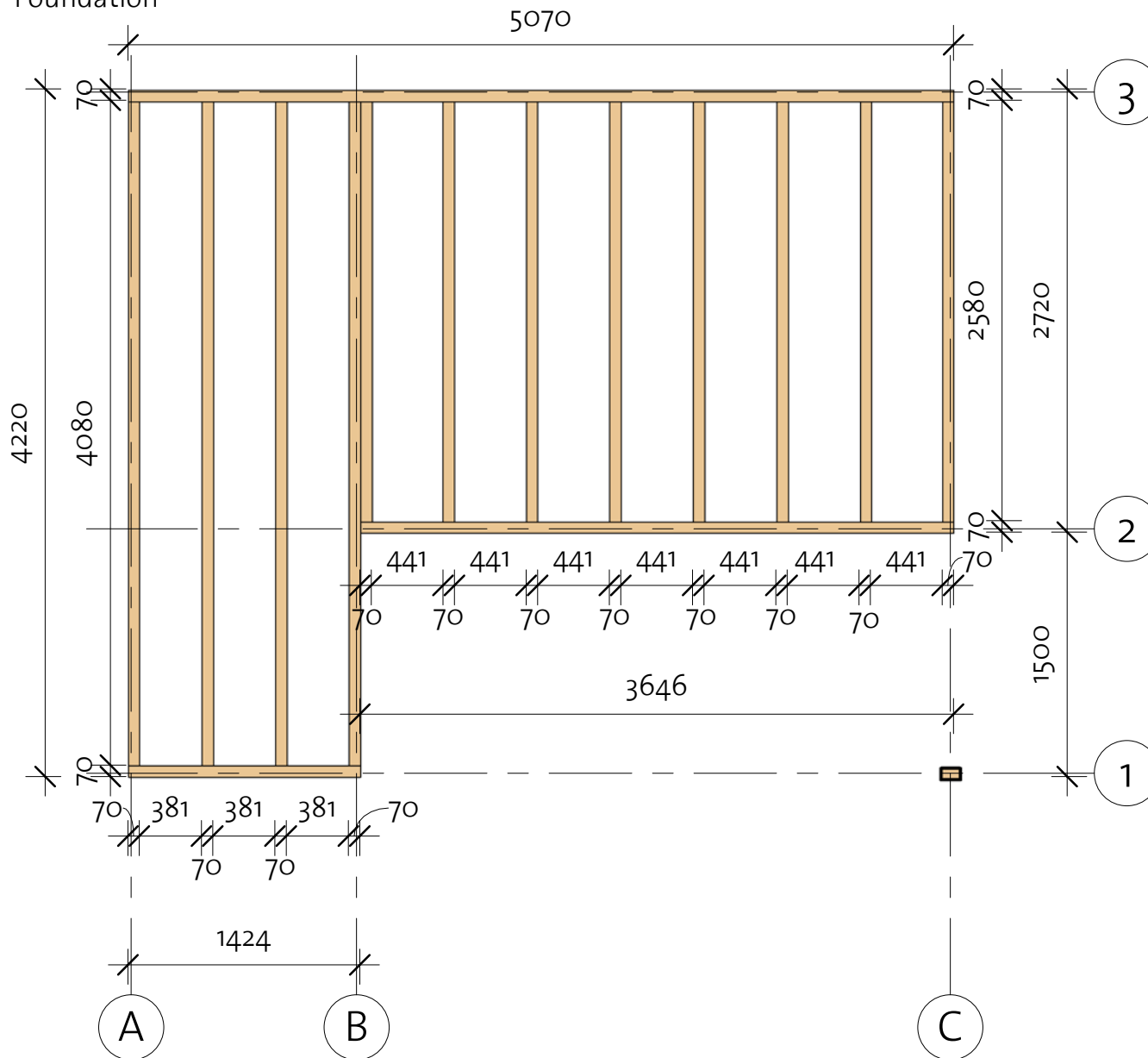

# Kramfors 70

Foundation



Impregnated foundation beams				
Mark	Type	Profile	Count	Length
IFB1	IFB		1	5070
IFB2	IFB		4	4080
IFB3	IFB		1	3646
IFB4	IFB		8	2580
IFB5	IFB		1	1424

# Kramfors 70

Floor Plan

Ⓛ Baseboard

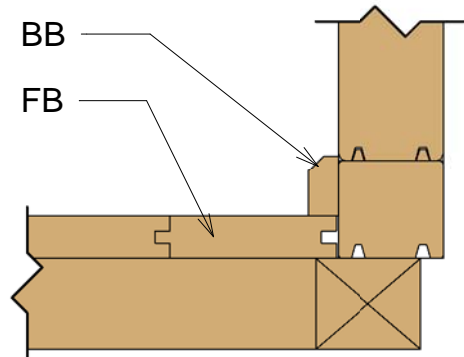

Floor Schedule

Mark	Type	Profile	Count	Length
------	------	---------	-------	--------

FB1	FB 28x110		25	3574
FB2	FB 28x110		38	1310

BB	BB 20x40		--	23.3 m
----	-------------	--	----	--------

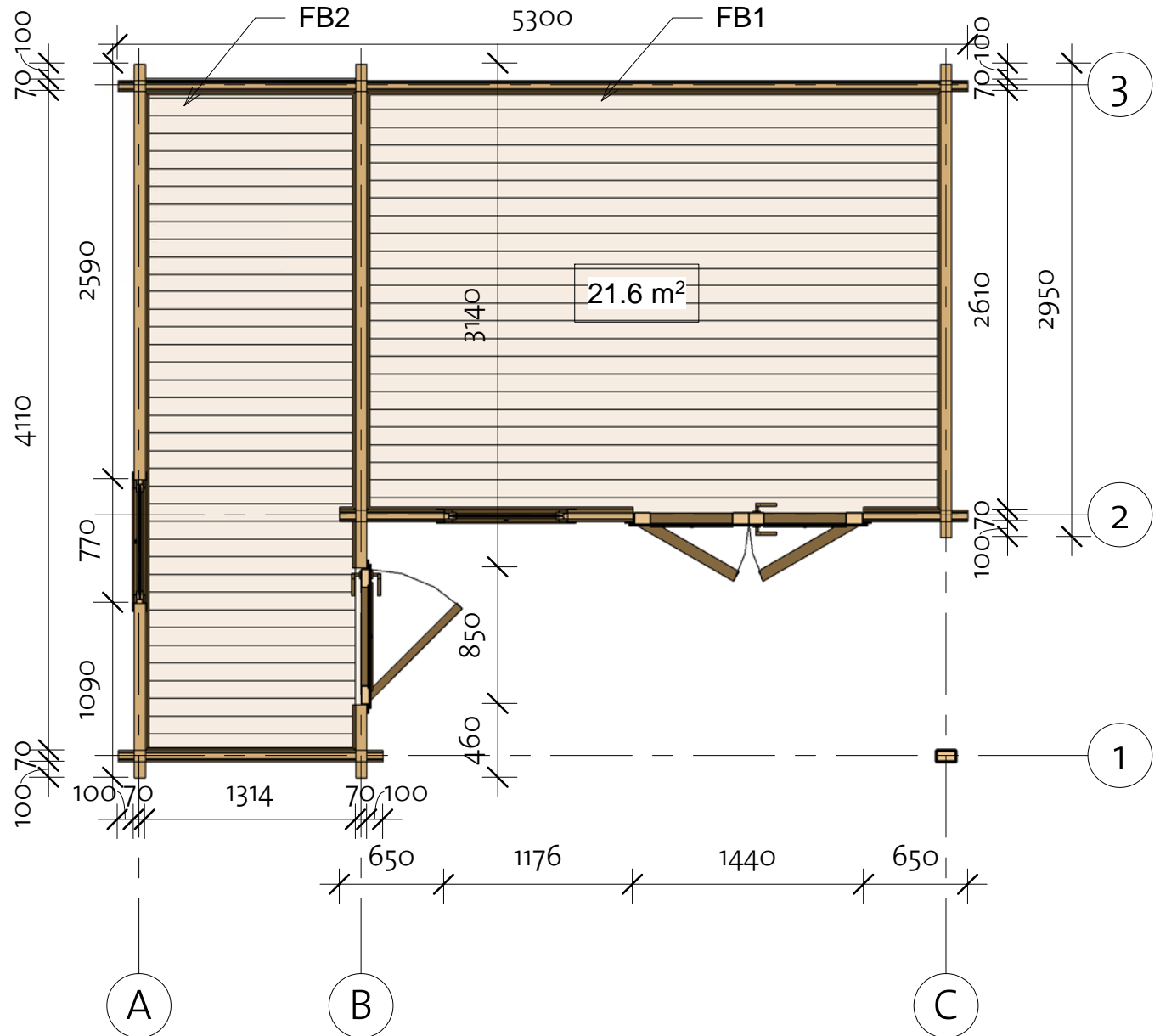



# Kramfors 70

Wall 2

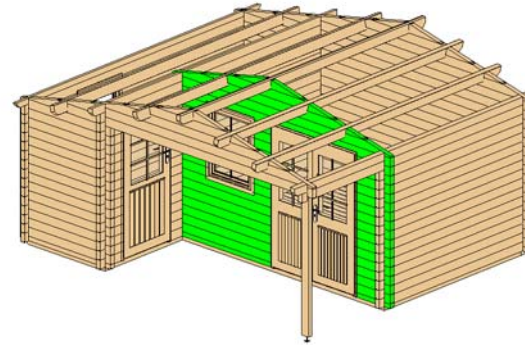

Wall 2			
Mark	Profile	Count	Cut Length

2BL 1	70x65	1	650
2BL 2	70x65	1	1826
2LG 1	70x130	8	406
2LG 2	70x130	23	650
2LG 3*	70x130	1	1274
2LG 4	70x130	7	1826
2LG 5*	70x130	1	2427
2LG 6*	70x130	1	3467
2LG 7	70x130	1	3916
2LG 8	70x130	1	3916

\* Gable - delivered premounted

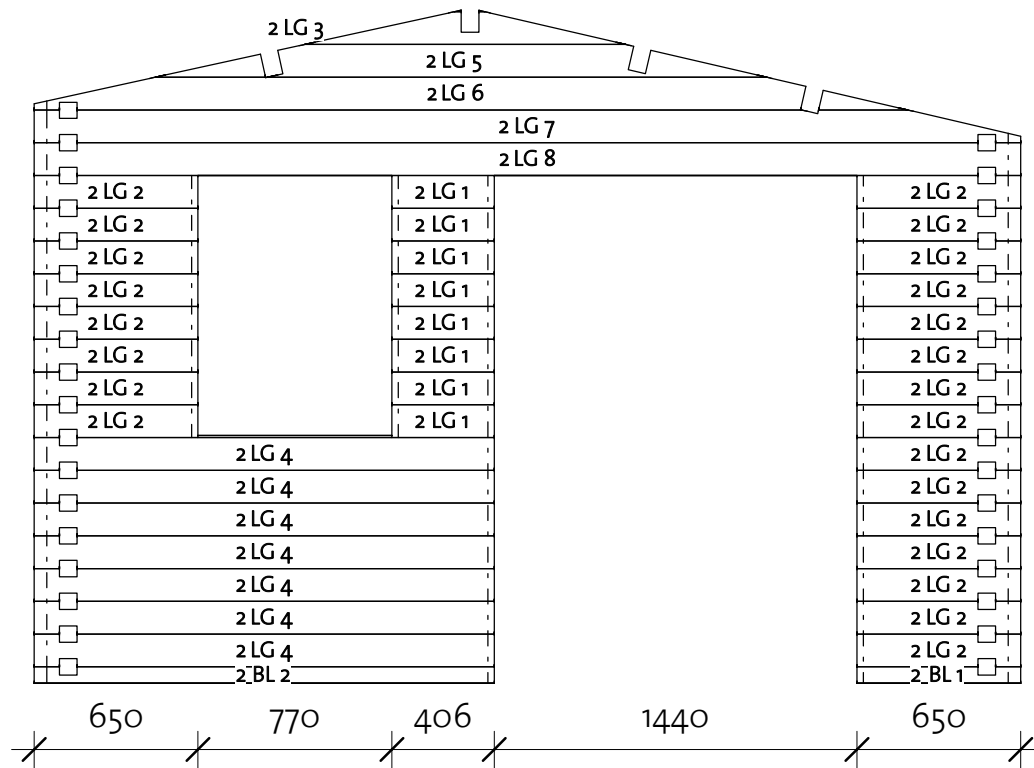

Log Profile Wall 2	
Profile	Profile

70x65	
70x130	

# Kramfors 70

Wall 3

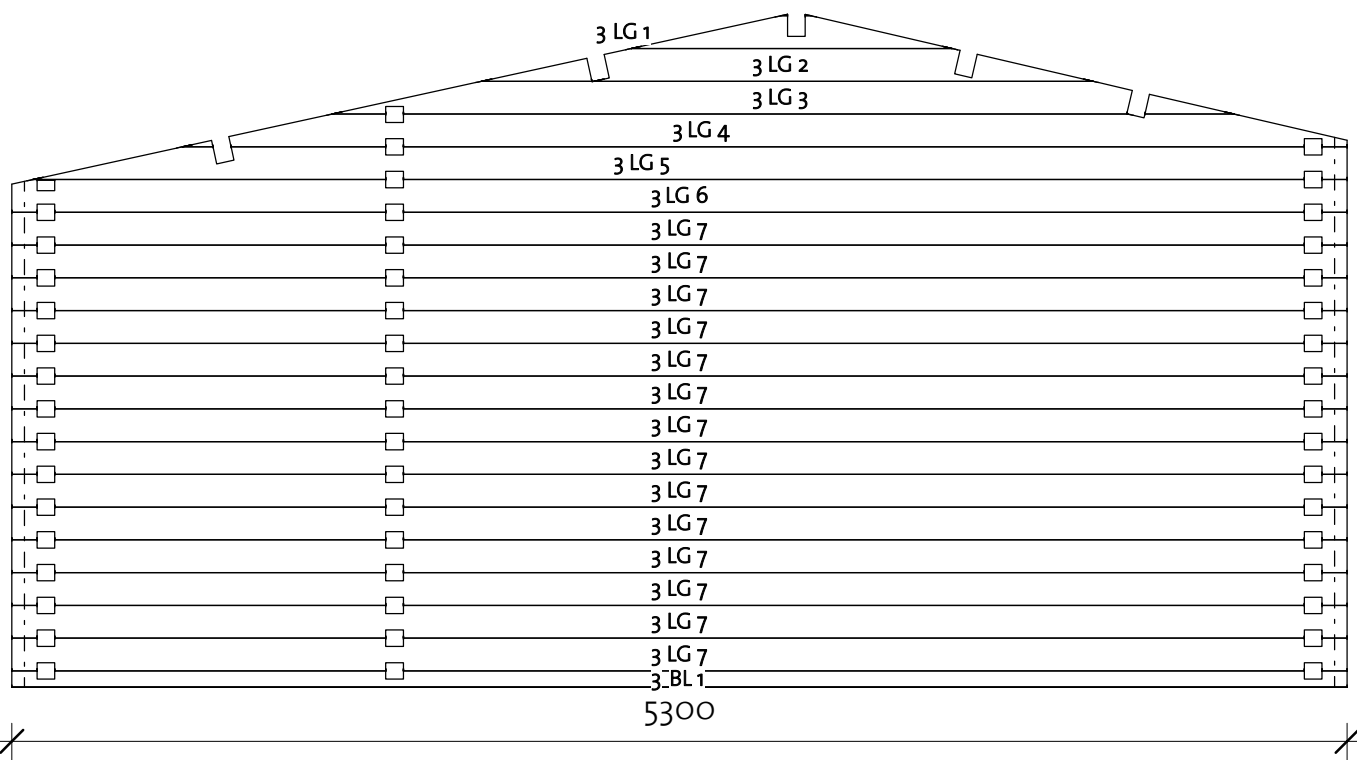
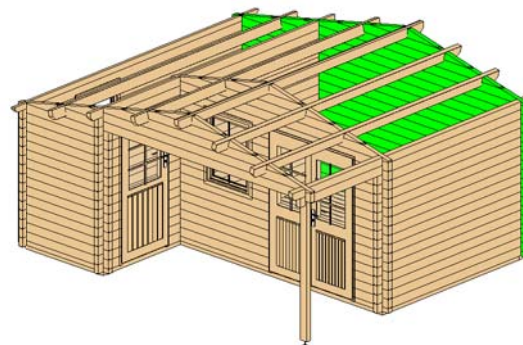

Wall 3



Mark	Profile	Count	Cut Length
------	---------	-------	------------

3BL 1	70x65	1	5300
3LG 1 *	70x130	1	1274
3LG 2 *	70x130	1	2427
3LG 3 *	70x130	1	3580
3LG 4	70x130	1	4623
3LG 5	70x130	1	5217
3LG 6	70x130	1	5300
3LG 7	70x130	14	5300

\* Gable - delivered premounted

Log Profile Wall 3

Profile	Profile
---------	---------

70x65	
70x130	

# Kramfors 70

Wall A

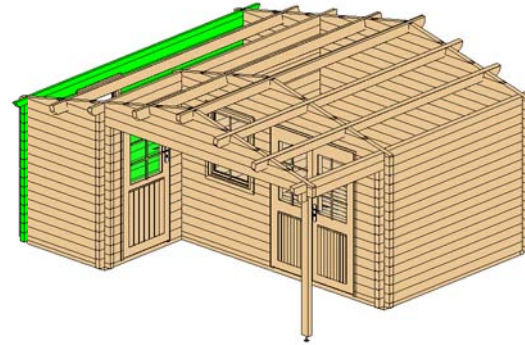

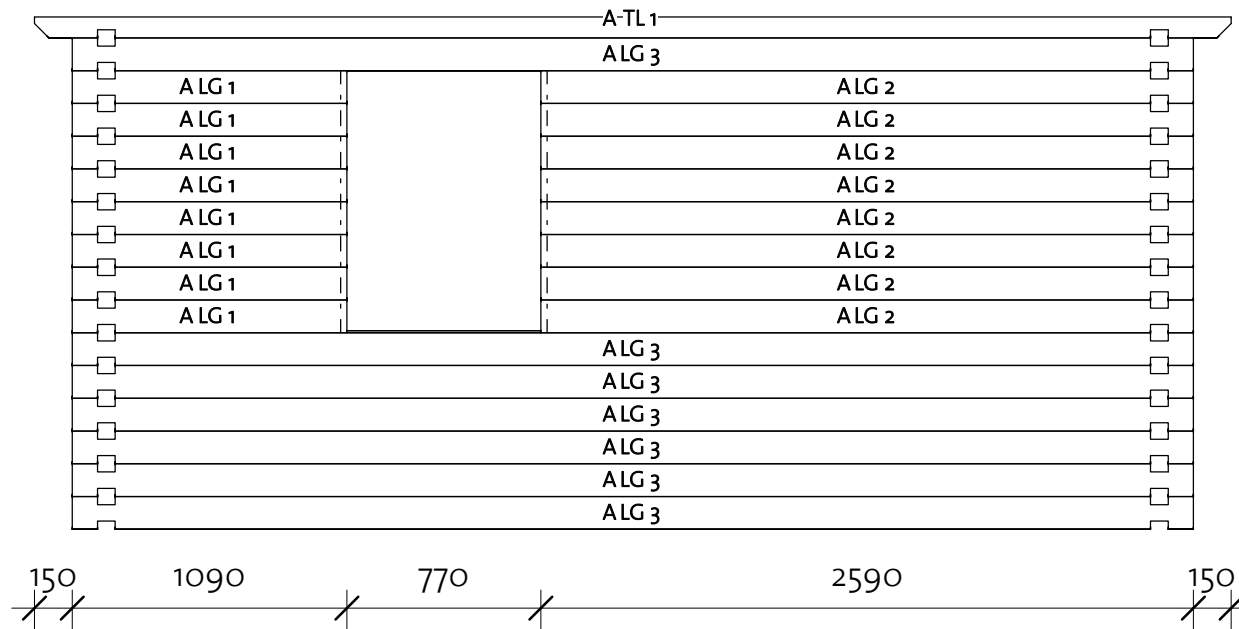

Wall A			
Mark	Profile	Count	Cut Length

ALG 1	70x130	8	1090
ALG 2	70x130	8	2590
ALG 3	70x130	7	4450
ATL 1	70x84	1	4750



Log Profile Wall A	
Profile	Profile

70x84	
70x130	

# Kramfors 70

Wall B

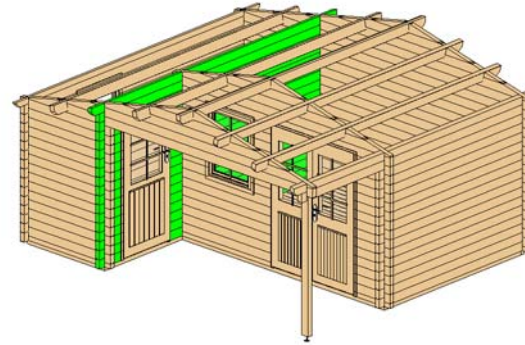

Wall B			
Mark	Profile	Count	Cut Length

BLG 1	70x130	15	460
BLG 2	70x130	15	3140
BLG 3	70x130	2	4450
BTL 1	70x127	1	4750

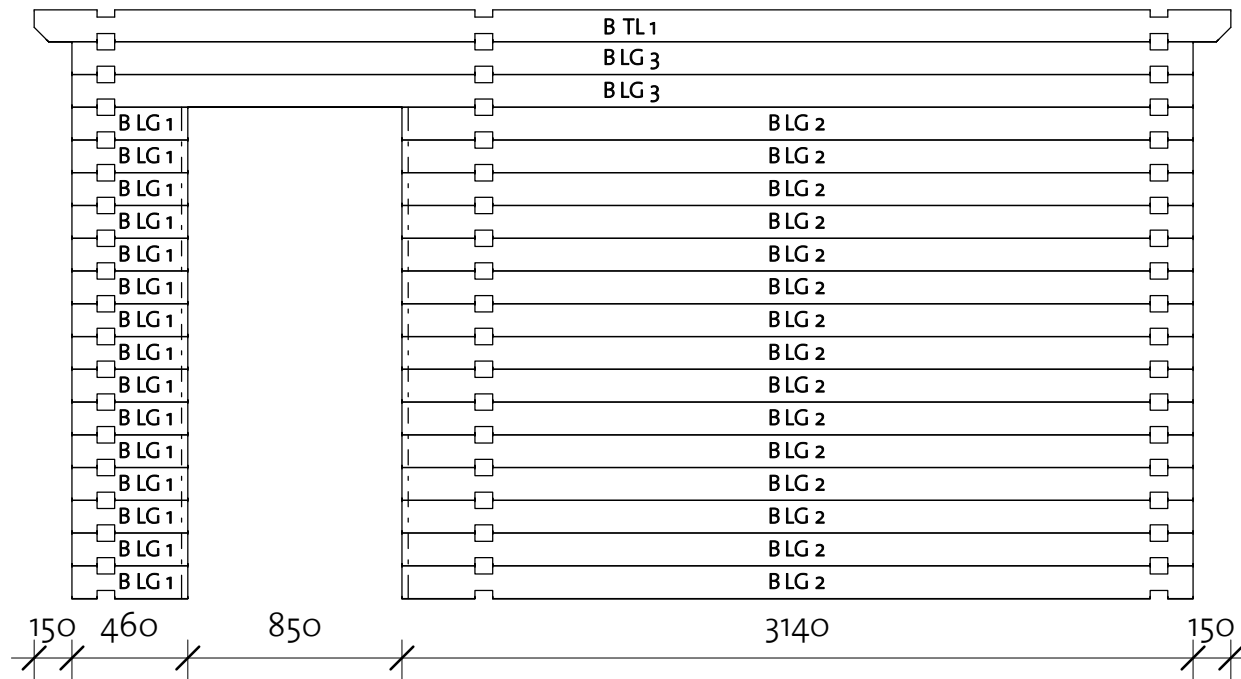

Log Profile Wall B	
Profile	Profile

70x127	
70x130	



# Kramfors 70

Wall C

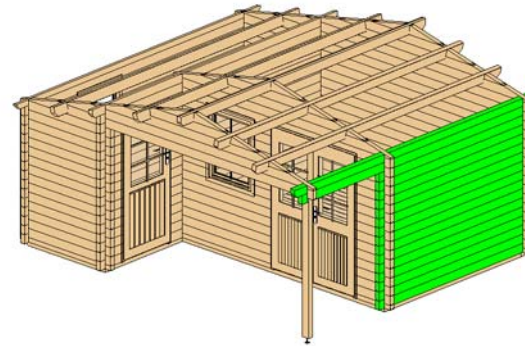

Wall C			
Mark	Profile	Count	Cut Length

CLG 1	70x130	15	2950
CLG 2	70x130	1	4450
CTL 1	70x130	1	4750

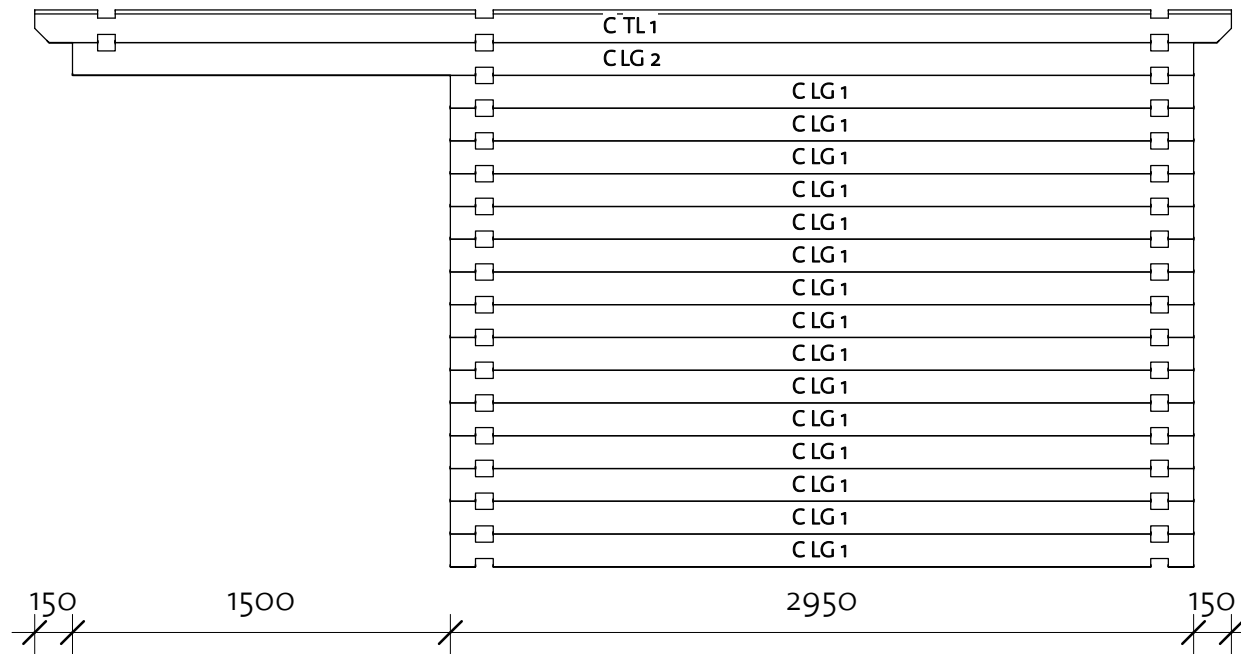

Log Profile Wall C	
Profile	Profile



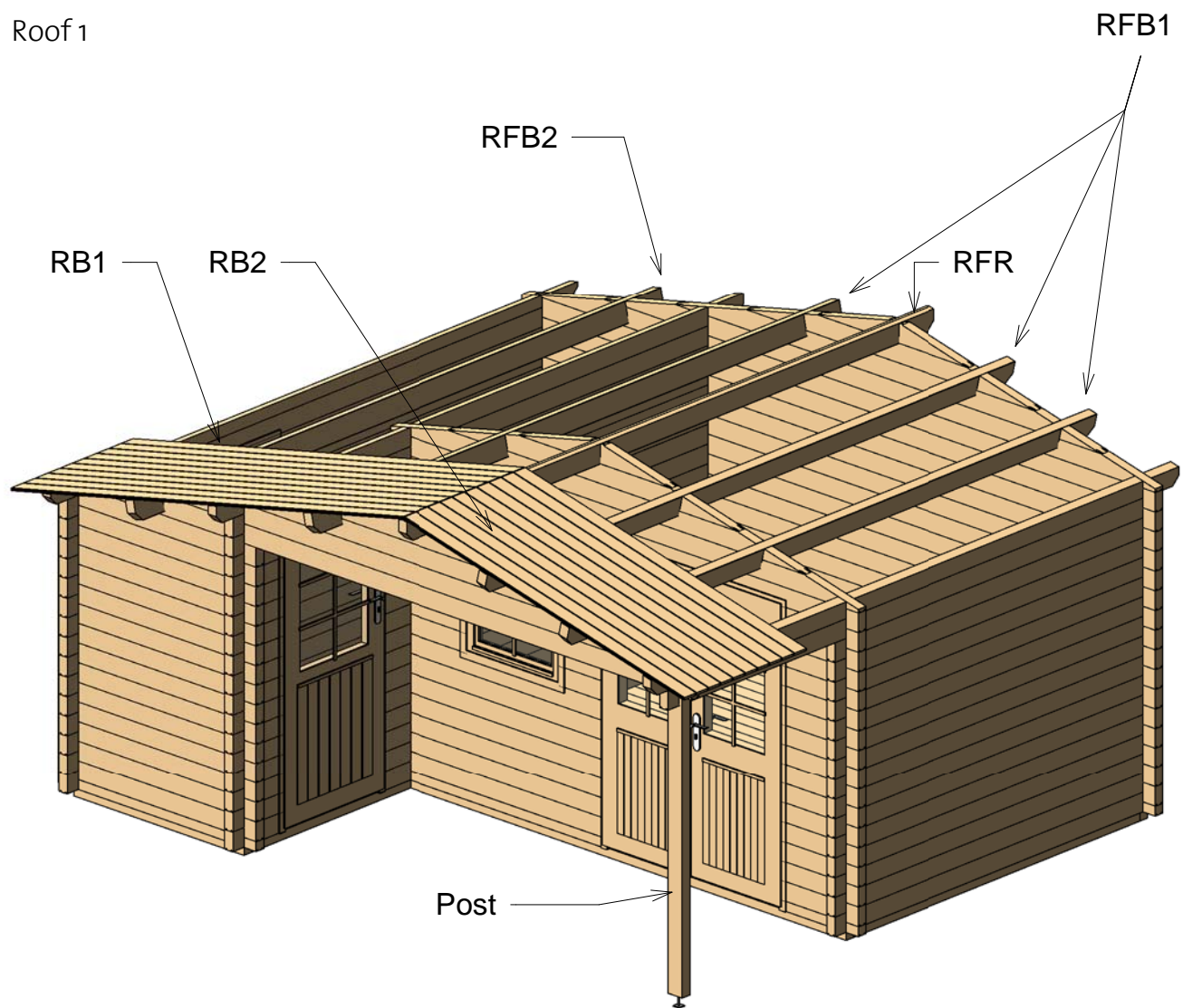

70x130	
70x130	

# Kramfors 70

Roof 1



Roof				
Mark	Type	Profile	Count	Length

RFR	Ridge 70x143		1	4750
RFB2	Beam 70x143		1	4750
RFB1	Beam 70x143		3	4750
RB1	Roofboard 18x110		45	3360
RB2	Roofboard 18x110		45	2410

# Kramfors 70

Roof 2

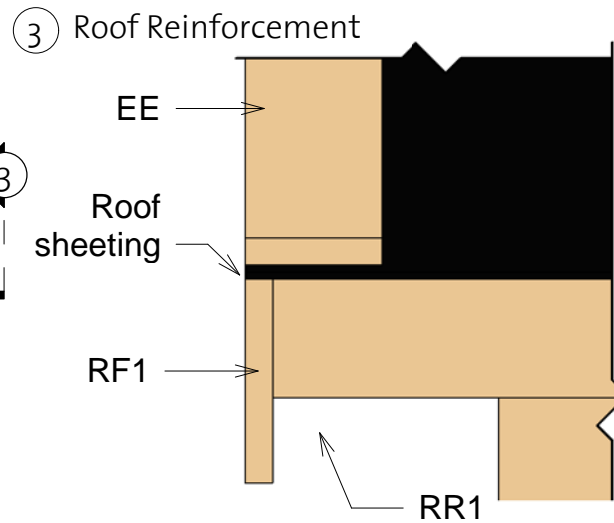
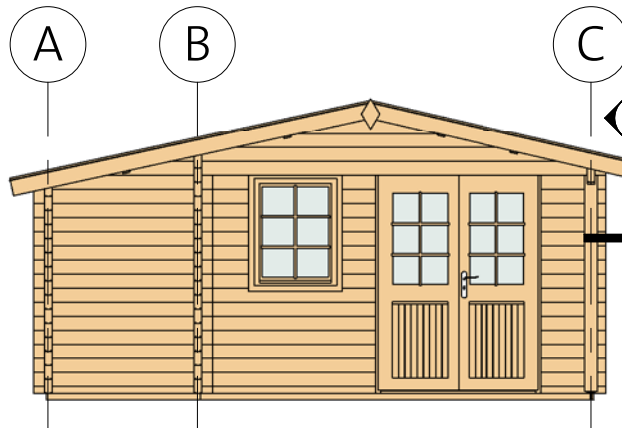
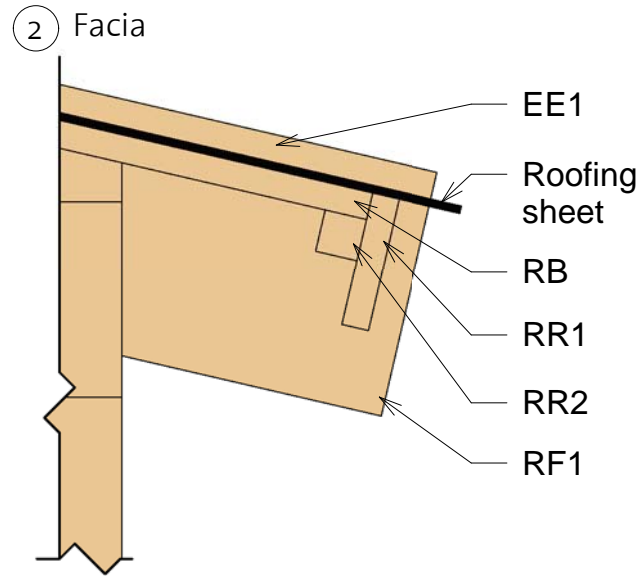
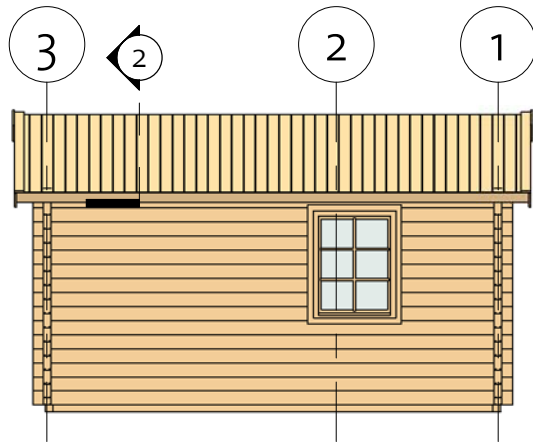

Fascia Schedule				
Mark	Type	Profile	Count	Length
EE1	Eave Edging 18x90		2	2453
EE2	Eave Edging 18x90		2	3410
RF1	Roof Fascia 18x143		2	2453
RF2	Roof Fascia 18x143		2	3410
RR1	Roof reinforcement 18x90		2	4750
RR2	Roof reinforcement 28x28		2	4750

# Kramfors 70

Extras

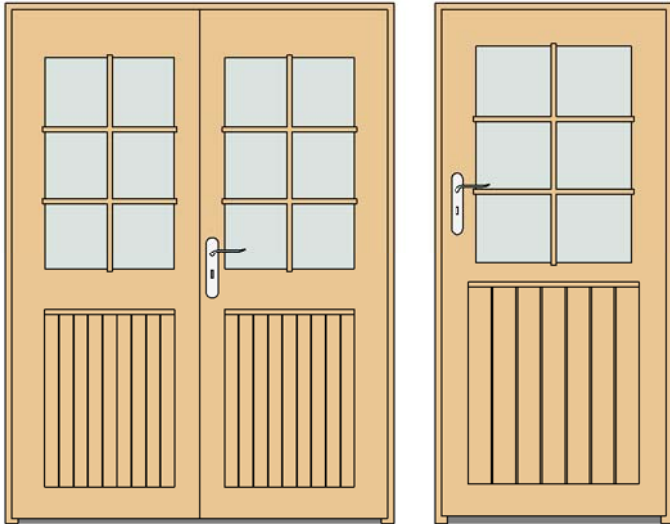

Door Schedule				
Mark	Type	Width	Height	Count
SDD1	Supreme double door 1	1425	1955	1
SD4	Supreme door 4	840	1975	1
DCB6	Door Crossbar 6	--	--	3

Family	Count
Romb	2



Fasteners/Extras		
Name	Type	Count

Hitblock	300-400 mm	
Screw thread Ø 8mm	180 mm	1
Screw thread Ø 8mm	2380 mm	1
Screw thread Ø 8mm	2250 mm	2
Screw thread Ø 8mm	2055 mm	3
Nut, washer	Ø 8mm	14
Screws	5,0 x 70	20
Screws	4,0 x 40	30
Screws	6,0 x 140	70
Screws	4,0 x 50	900



I

Post		
Type	Count	Length
Post 70x120	1	1995
Adjustable post foot	1	80

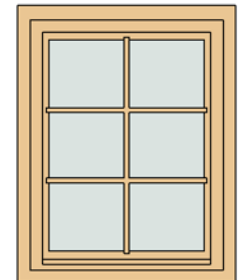

Window Schedule				
Mark	Type	Width	Height	Count
SW1R	Supreme window 1 right	765	990	2
WCB6	Windows Crossbar 6	--	--	2





# Kramfors 70

## List of all items 1

### Impregnated foundation beams

Mark	Type	Profile	Count	Length
IFB1	IFB 70x60		1	5070
IFB2	IFB 70x60		4	4080
IFB3	IFB 70x60		1	3646
IFB4	IFB 70x60		8	2580
IFB5	IFB 70x60		1	1424

### Roof







Mark	Type	Profile	Count	Length
RFR	Ridge 70x143		1	4750
RFB2	Beam 70x143		1	4750
RFB1	Beam 70x143		3	4750
RB1	Roofboard 18x110		45	3360
RB2	Roofboard 18x110		45	2410

### Floor Schedule

Mark	Type	Profile	Count	Length
FB1	FB 28x110		25	3574
FB2	FB 28x110		38	1310

BB	BB 20x40		--	23.3 m
----	-------------	---	----	--------

### Fascia Schedule

Mark	Type	Profile	Count	Length
EE1	Eave Edging 18x90		2	2453
EE2	Eave Edging 18x90		2	3410
RF1	Roof Fascia 18x143		2	2453
RF2	Roof Fascia 18x143		2	3410
RR1	Roof reinforcement 18x90		2	4750
RR2	Roof reinforcement 28x28		2	4750

# Kramfors 70

## List of all items 2

Wall 1			
Mark	Profile	Count	Cut Length

1BL 1	70x65	1	1654
1LG 1 *	70x130	1	1274
1LG 2	70x130	1	1654
1LG 3	70x130	14	1654
1LG 4 *	70x130	1	2427
1LG 5 *	70x130	1	3580
1LG 6	70x130	1	4623
1LG 7	70x130	1	5130

Wall 3			
Mark	Profile	Count	Cut Length

3BL 1	70x65	1	5300
3LG 1 *	70x130	1	1274
3LG 2 *	70x130	1	2427
3LG 3 *	70x130	1	3580
3LG 4	70x130	1	4623
3LG 5	70x130	1	5217
3LG 6	70x130	1	5300
3LG 7	70x130	14	5300

Log Profiles 1	
Profile	Profile

70x65	
70x130	

Wall 2			
Mark	Profile	Count	Cut Length

2BL 1	70x65	1	650
2BL 2	70x65	1	1826
2LG 1	70x130	8	406
2LG 2	70x130	23	650
2LG 3 *	70x130	1	1274
2LG 4	70x130	7	1826
2LG 5 *	70x130	1	2427
2LG 6 *	70x130	1	3467
2LG 7	70x130	1	3916
2LG 8	70x130	1	3916

\* Gable - delivered premounted

# Kramfors 70

## List of all items 3

Wall A			
Mark	Profile	Count	Cut Length

ALG 1	70x130	8	1090
ALG 2	70x130	8	2590
ALG 3	70x130	7	4450
ATL 1	70x84	1	4750



Wall B			
Mark	Profile	Count	Cut Length

BLG 1	70x130	15	460
BLG 2	70x130	15	3140
BLG 3	70x130	2	4450
BTL 1	70x127	1	4750

Wall C			
Mark	Profile	Count	Cut Length

CLG 1	70x130	15	2950
CLG 2	70x130	1	4450
CTL 1	70x130	1	4750

Log Profiles 2	
Profile	Profile

70x65	
70x130	
70x84	

Log Profiles 2	
Profile	Profile

70x127	
70x130	